



■ Vers.



■ Vers. 446



■ Vers. 009



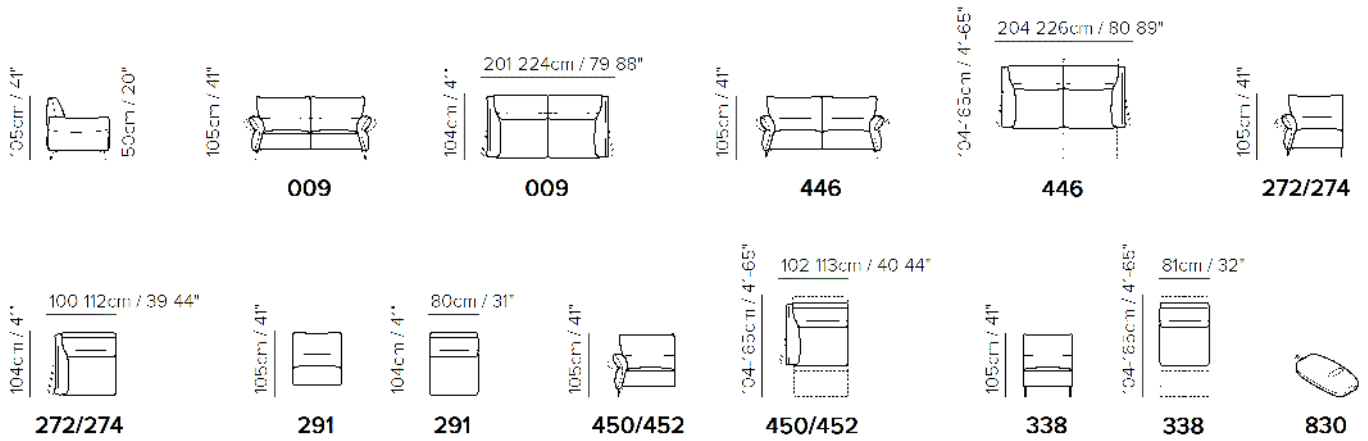

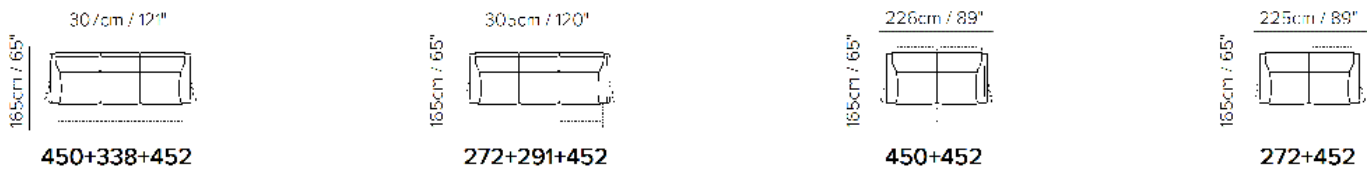

SCHEMATICS



COMPOSITION EXAMPLES



TECHNICAL INFORMATION

	COVERING	Leather <input checked="" type="checkbox"/>	Soft Cover <input checked="" type="checkbox"/>				
	LEGS	Wood <input type="checkbox"/>	Metal <input type="checkbox"/>	Plastic <input type="checkbox"/>	Castors <input type="checkbox"/>	Upholstered <input type="checkbox"/>	
	FILLING	Arms	<input type="checkbox"/> Fiber <input checked="" type="checkbox"/> Foam <input type="checkbox"/> Feather/Fiber Mix <input type="checkbox"/> Feather	Seat cushion	<input type="checkbox"/> Fiber <input checked="" type="checkbox"/> Foam <input type="checkbox"/> Feather/Fiber Mix <input type="checkbox"/> Feather	Back cushion	<input type="checkbox"/> Fiber <input checked="" type="checkbox"/> Foam <input type="checkbox"/> Feather/Fiber Mix <input type="checkbox"/> Feather
	COMFORT	Standard Comfort <input checked="" type="checkbox"/>	Firm Comfort <input checked="" type="checkbox"/>				
	FUNCTION	Bed <input type="checkbox"/>	Electric motion <input checked="" type="checkbox"/>	Motion <input checked="" type="checkbox"/>	Recliner <input type="checkbox"/>	Sliding <input type="checkbox"/>	
	OPTIONS	Nails <input type="checkbox"/>	Removable <input type="checkbox"/>	Contrast Stitching <input type="checkbox"/>			

NOTES

NOTES
